

⚠ Caution | Do not mark on the model and other components with pen nor leave printed materials contacted on surface.
Ink marks on the models cannot be removed.

MW19

Difficult Airway Management Simulator

Fiberscope Model

Instruction Manual



Contents

- Introduction P. 1
Manufacturer's Note
DOs and DON'Ts
- Before You Start P. 2
Set Includes
- Preparation
Check points before training P.3
Preparation of the model P.4
Setting of DAM P.5~P.8
- Replacement of the Consumable Parts ... P.9~P.13
- After Training P.14

Manufacturer's note

The Difficult Airway Management (D.A.M.) Simulator Fiberscope model facilitates trainings in insertion and management of a fiberscope. Anatomically correct trachea and bronchi provides realistic view through a scope, allowing recognitions of bifurcations. Varying degrees of challenge to trainees can be set by combinations of controllable degree of mouth opening, changeable limit of neck flexibility and inflatable tongue.

● Features

- Anatomically correct trachea and bronchi that includes trachea bifurcation for segmental bronchi
- Latex free
- Made in Japan

This D.A.M simulator Training Model has been developed for the training of medical and paramedical professionals only. Any other use, or any use not in accordance with the enclosed instructions, is strongly discouraged. The manufacturer cannot be held responsible for any accident or damage resulting from such use. Please use this model carefully and refrain from subjecting to any unnecessary stress or wear. Should you have any questions on this simulator, please feel free to contact our distributor in your area or KYOTO KAGAKU at any time. (Our contact address is on the back cover of this manual)

DOs and DON'Ts

DOs

- Handle the manikin and the components with care.
- Storage in a dark, cool space will help prevent the skin colours from fading.
- The manikin skin may be cleaned with a wet cloth, if necessary, using mildly soapy water or diluted detergent.

DON'Ts

- Do not let ink from pens, newspapers, this manual or other sources contact with the manikin, as they cannot be cleaned off the manikin skin.
- Never use organic solvent like paint thinner to clean the skin, as this will damage the simulator.
- Even if color on its surface might be changed across the ages, this does not affect the quality of its performance.

Set Includes

Before you start, ensure that you have all components listed below.

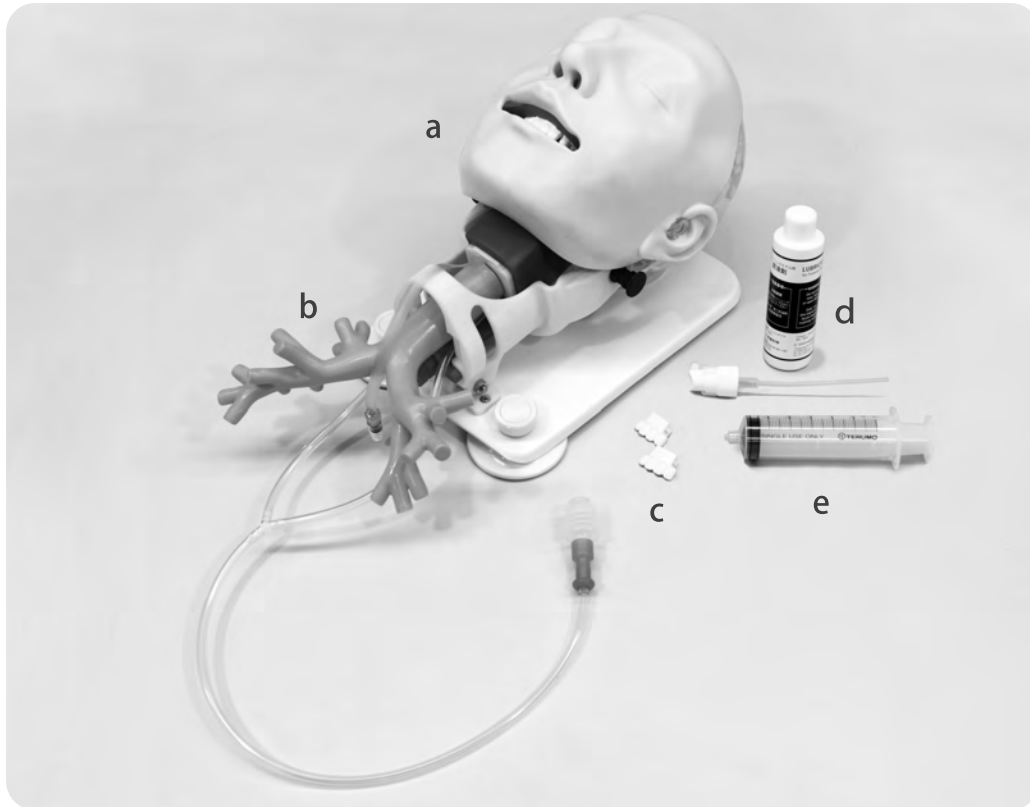

- | | | | |
|-------------------|---|-------------------------------------|---|
| a. Torso body | 1 | d. Lubricant | 1 |
| b. Bronchi part | 1 | e. Syringe (50mL) | 1 |
| c. Upper incisors | 3 | 1 bag for model, instruction manual | |

Consumable parts

code	name
11393-010	Face mask 1
11392-030	Replacement tongue 1
11229-050	Lubricant 1



11393-010



11392-030



11229-050

1 Check points before training

1. Open the mouth of the model to check the installation condition of the tongue.
Ensure that the pin behind the tip of the tongue has not fallen out from the hole on the mandible.

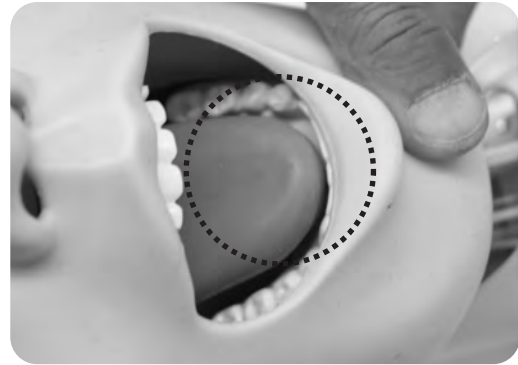

The tongue is correctly installed

2. Then check whether the tongue fixing part and the throat part are correctly installed.



Incorrect installation

(* The photo is taken while the head is removed to allow to see the condition clearly.)

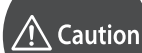
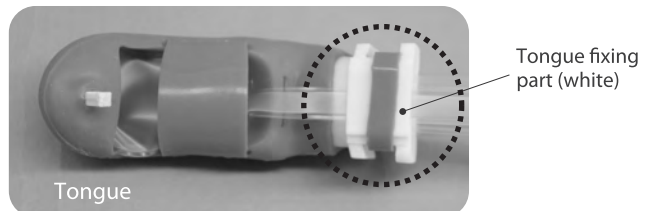
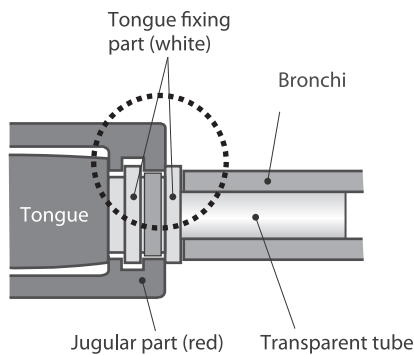

Caution

.....
If the parts enclosed in the dotted circle are not correctly engaged with each other, the tongue will fall out during training.

3. Ready for training session.

1 Fixation of the model

Conduct any training on a table with a flat and smooth surface. Turn the sucker fixing knobs installed in two positions on the base of the model clockwise to fix the model on the table. Turn them counter-clockwise to remove the model.



When removing the model, detach the sucker installed on the back of the base.

2 Connect the bronchi part

1. Connect the bronchi part.

The bronchi part please do not make a mistake in right and left. (The right side of the bronchi part are long.)

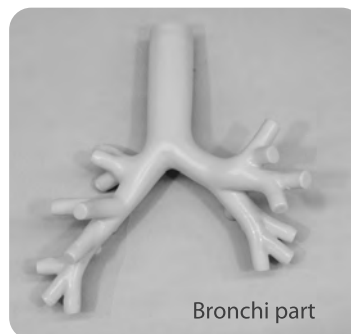

3 Put enough lubricant

1. Put enough lubricant to the mode and the fiberscope before inserting the fiberscope tube.

For nasotracheal airway, spray the lubricant in the cavitas nasi and the tube. For oral route airway, in the mouth and the tube.



Caution

Use the lubricant included in the set. Others like gel type may remain in the model and become irremovable.

This model can be set by combinations of controllable degree of mouth opening, changeable limit of neck flexibility, inflatable tongue and laryngospasm.

Please set it beforehand as needed.

* At the time of delivery setting of DAM is normal entirely.

1 Neck Flexibility

You can select either of two levels of difficulty: normal neck and rigid neck.



Normal



Rigid

Change the range of motion of the neck with the black level-switching knobs on the both sides of the neck of the model.

Turn the knobs while pulling them to the outside to adjust the depth to which the knobs are inserted.

1. To conduct training for the normal condition, align the knobs to the position where you can see the green seal as shown in the photo. Always set up the knobs on both sides identically to each other.

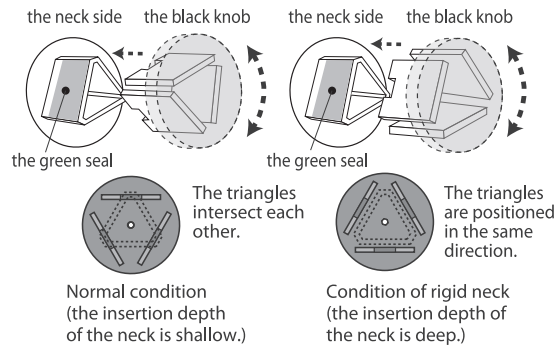
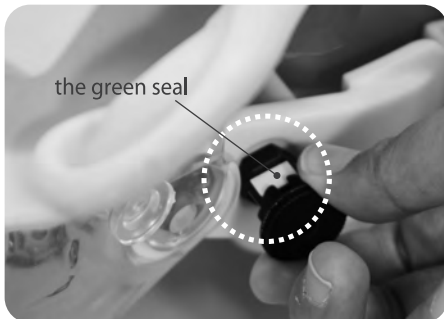

2. To change the setting to the condition of difficulty in neck recurvation, turn the knob while pulling it to align the foot of the triangle to the same direction as that of the receptacle parts on the model. Push the knob until the green seal disappears. You can also lock the setting by returning the position of the head to the direction indicated in the photo below.



Caution

.....
Conduct any training after setting the knobs on both sides to the same setting.
If the knobs are set in different settings, it might cause breakage and/or failure.

2 Degree of the Mouth Opening

You can select one of three levels of difficulty: Easy (Normal) [normal condition], Intermediate [mouth opening difficulty level 1] and Difficult [mouth opening difficulty level 2].



Normal (easy)



Intermediate



Difficult

Set the mouth opening limitation with the black level-switching knob on the top of the head of the model. Move the knob up or down while pulling it, and then release it on either of the indicated level lines to lock the setting.

1. To conduct training for the normal condition, align the knob to the Easy (Normal) position.

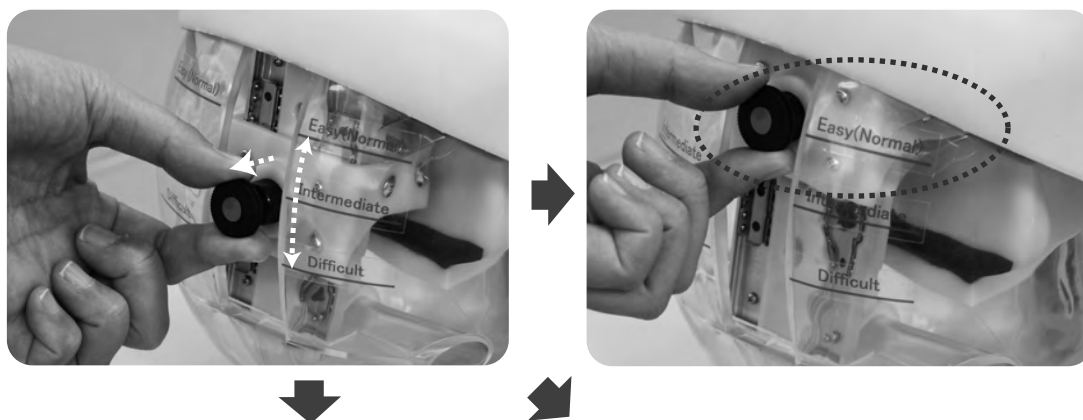

2. To change the condition of the mouth opening difficulty level, move the knob up while pulling it, and then release it on the Intermediate position [mouth opening difficulty level 1] or Difficult position [mouth opening difficulty level 2].

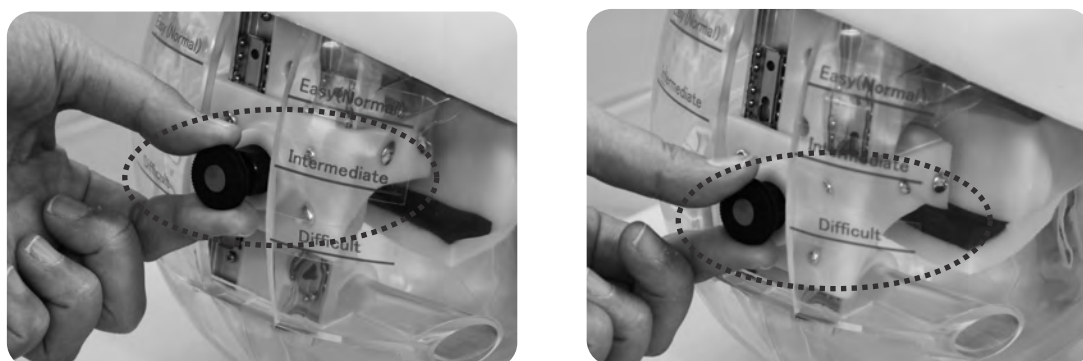

3 Tongue Edema

The size of the tongue can be set in two levels: normal tongue and swollen tongue.



Normal



Swollen

To adjust the condition of the swollen tongue, inject/extract air to/from the tongue by using the attached syringe to change the size of the tongue.

1. To set the tongue to normal condition, do not inject air.
2. To simulate the condition of swollen tongue, intake **20mL** of air into the attached syringe and then connect it to the flat tube located in the neck of the model. The syringe is provided with a lock mechanism. Insert the tip of the syringe to the connector on the end of the tube and then turn the syringe clockwise. After injecting the air into the tongue to simulate swollen tongue condition, turn the syringe counter-clockwise to detach it from the tube.

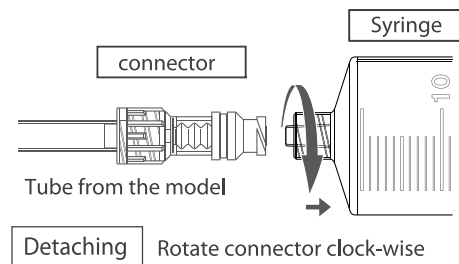
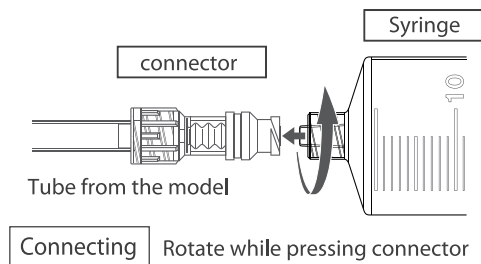
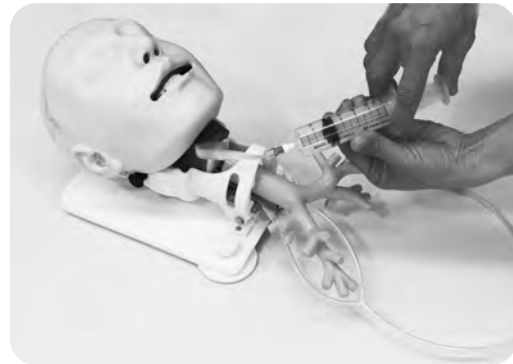
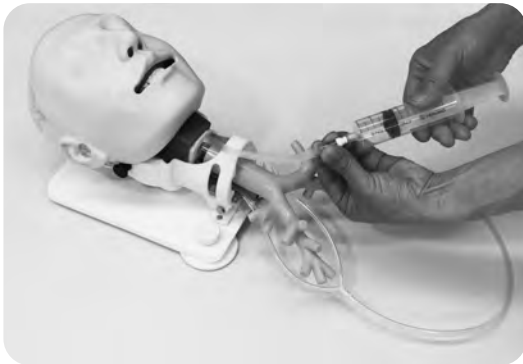

3. To restore the tongue to the normal condition, connect an empty syringe to the tube by using the procedure in the step 2 to extract the air in the tongue to restore the size of the tongue to normal.

4 Laryngospasm

You can select either of two levels of difficulty: normal and laryngospasm.

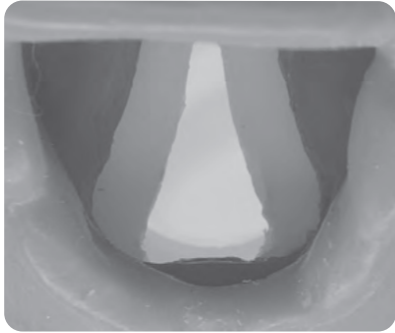

Normal

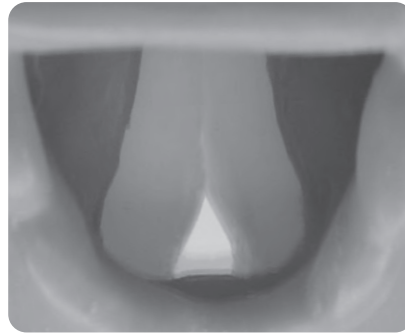

Laryngospasm

By pressing the pump on the end of the tube attached to the main body, you can simulate the laryngospasm.

1. The condition of laryngospasm is simulated while the pump is being pressed. The condition returns to normal when the pump is released.

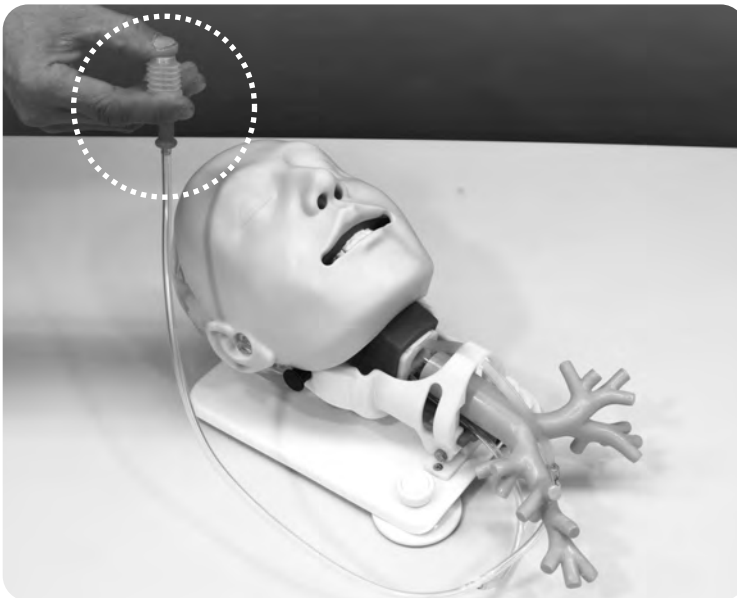

The condition returns to normal when the pump is released.

Laryngospasm is simulated while the pump is being pressed.



* The photos show the tongue component that is detached from the model to allow visibility of the condition.

1 Upper Incisors

Widen the mouth and then place the protruded part behind the part where the incisor component is installed into the groove on the upper jaw.

Then push up the incisor component toward the front direction until you hear a "click" sound.



2 Tongue

1. Set the range of motion in neck recurvation to the normal condition. Then set the mouth opening limitation to the Easy (Normal) condition.
(Refer to P. 4 and P. 5 respectively for the setting procedures.)

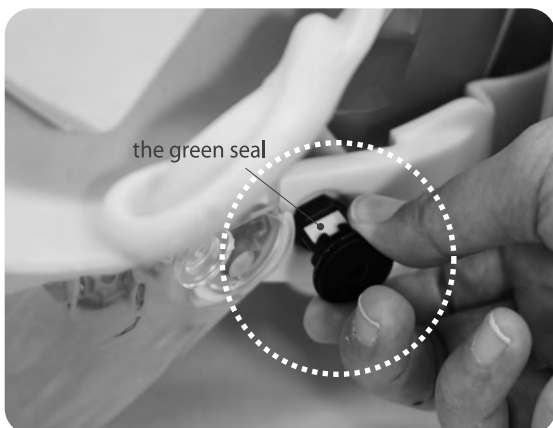

Turn the black knob to the normal position where the green seal appears.

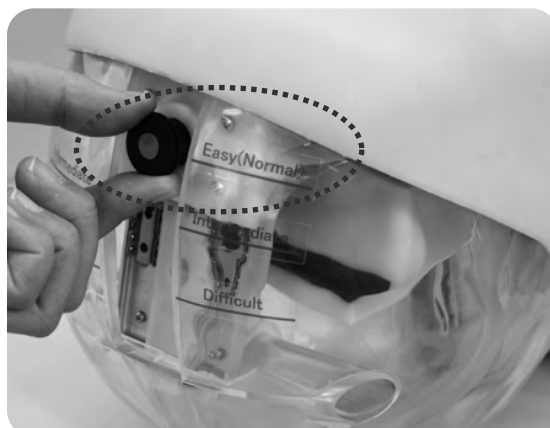

Move the black knob to the Easy (Normal) position.

2 Tongue

2. Remove the face mask from buttons at ears and then remove the mask from the head..



3. Disconnect the transparent tube and bronchi part by pulling the bronchi part. Then disconnect the tube for laryngospasm.

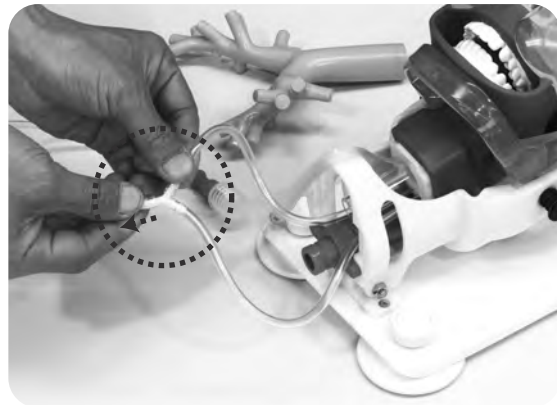
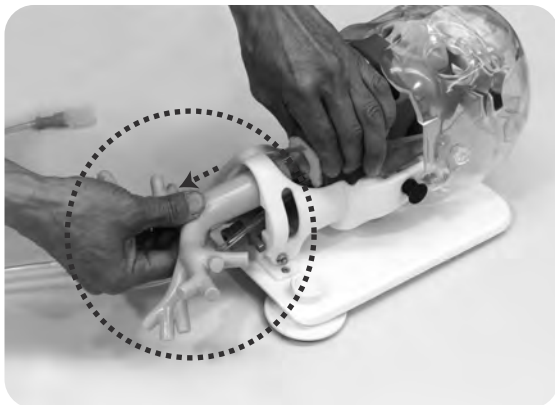

4. Remove the pin on the tip of the tongue from the hole on the lower teeth.



2 Tongue

5. Disengage the lower part of the throat from the tongue fixing part, then pull down the tongue component to detach. It becomes easy to pull out the whole tongue component when the tongue is pushed into the mouth while pulling it out.

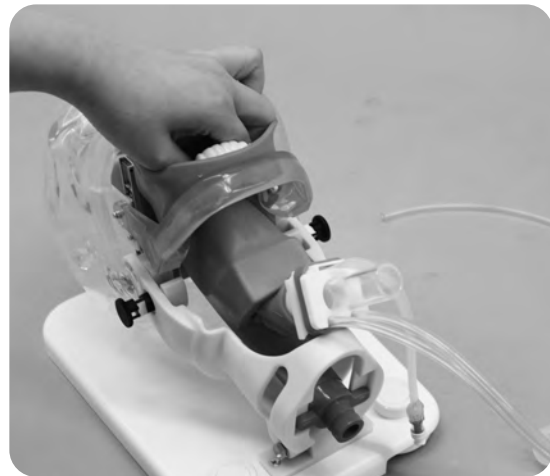
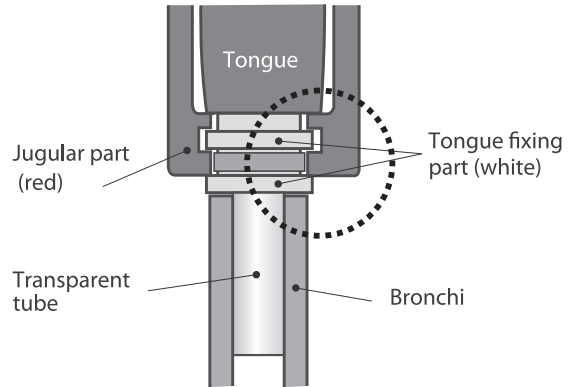

.....
Caution Slowly pull out the tongue component from the throat with care. If it is pulled out forcibly, it could break.

2 Tongue

6. After confirming the tongue direction, insert half of it into the throat from the opening. Insertion is more easily facilitated by applying training model lubricant on it.



7. Push the tongue component into the throat from the throat side. Open the mouth, hold the tongue when a certain portion of it comes into the oral cavity, then pull it until the tip of the tongue touches the incisors. Ensure that the air bag installed in the tongue is not displaced.

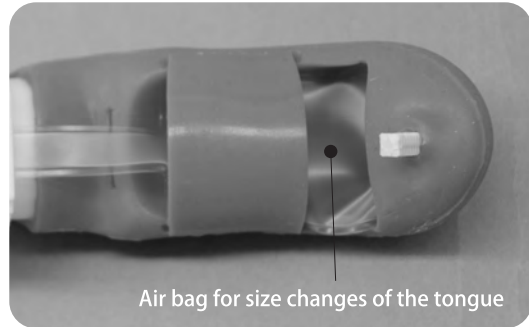

8. Widen the lower part of the throat and engage it with the lower part of the tongue fixing part. Ensure that the entire perimeter is engaged properly.

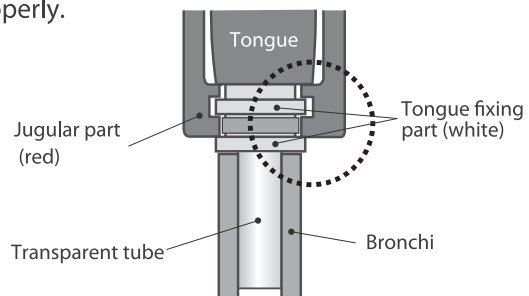

9. Insert the pin on the tip of the tongue into the hole on the mandible.



Example of inappropriate installation of tongue component



3 Tongue

9. Connect the laryngospasm tube.



10. Connect the bronchus component.



11. Set the mask on the face.



12. Fit the both of the ear holes on the mask to the head of the model.



4 Face Mask

1. Take off the face mask. Then set the new mask on the face and fit the both of the ear holes on the mask to the head of the model.



After Training

After Training

Clean and remove the lubricant on the face with water or diluted detergent. Talcum powder may be used on the face mask after use to preserve suppleness of the skin and prevent it from being stained. Before storage, ensure that model is dry.





Caution

Don't mark on the model and other components with pen or leave printed materials contacted on their surface.
Ink marks on the models will be irremovable.

- For inquiries and service, please contact your distributor or KYOTO KAGAKU CO., LTD.

 **KYOTO KAGAKU co.,LTD**

URL•<http://www.kyotokagaku.com> e-mail•rw-kyoto@kyotokagaku.co.jp



■ Main Office and Factory

15 Kitanekeoya-cho Fushimi-ku Kyoto 612-8388, Japan
Telephone : 81-75-605-2510
Facsimile : 81-75-605-2519

■ LA Office (for USA , CANADA and Mexico customers)

3109 Lomita Boulevard, Torrance, CA 90505 ,USA
Telephone : 1-310-325-8860
Facsimile : 1-310-325-8867

The contents of the instruction manual are subject to change without prior notice.

No part of this instruction manual may be reproduced or transmitted in any form without permission from the manufacturer.

Please contact manufacturer for extra copies of this manual which may contain important updates and revisions.

Please contact manufacturer with any discrepancies in this manual or product feedback. Your cooperation is greatly appreciated.